

Overview

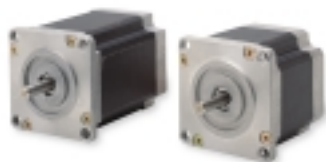

Features

- Sizes 17, 23, 34 and 42
- Optimized for use with IDC's microstepping controls
- Bipolar current ratings for use with IDC's microstepping controls
- High torque-to-inertia, yielding high acceleration
- 120°C rated Class B winding
- 12-ft motor cables standard
- Encoder optional (sizes 23, 34, 42); see page G-61
- Quick disconnect motor cabling option (sizes 34 and 42)

Model	Holding Torque oz-in [N-m]	Recommended Current/Phase Series [Parallel]	See page
S12	30 [0.25]	1.0 [2.0]	G-47
S21	65 [0.46]	1.2 [2.4]	G-48
S22	100 [0.71]	1.5 [3.0]	G-49
S23	125 [0.88]	1.75 [3.5]	G-50
S32	300 [2.1]	2.8 [5.6]	G-53
S33	400 [2.8]	3.5 [7.0]	G-54
P21	100 [0.7]	0.7 [13]	G-51
P22	200 [1.4]	1.0 [2.0]	G-52
P31	450 [3.2]	1.5 [3.0]	G-55
P32	920 [6.5]	1.6 [3.3]	G-56
P33	1260 [8.9]	2.0 [4.0]	G-57
P41	1250 [8.8]	2.8 [5.7]	G-58
P42	2300 [16.2]	3.3 [6.6]	G-59
K42	3000 [21.2]	3.2 [6.4]	G-60



How To Order

Motor Models	Options	Description
S12	None	EMK - 1000 line encoder option with 12-ft, jacketed cable
S21, S22, S23	EMK	EM - 500 line encoder option with 12-ft, jacketed cable
P21, P22	EM	EQK - 1000 line encoder with 12-ft quick disconnect cable
		EQ - 500 line encoder with 12-ft quick disconnect cable
S32X, S33X	EMK	EQK25 - 1000 line encoder with 25-ft quick disconnect cable
	EM	EQ25 - 500 line encoder with 25-ft quick disconnect cable
	C25	C25 - 25-ft quick disconnect motor lead cable
P31X, P32X, P33X	EMK	A 30% torque safety margin is recommended when applying step motors.
P41X, P42X	EM	
K42X	EQK	
	EQ	
	EQK25	
	EQ25	
	C25	

Replace the Xs in the above part numbers with N, T or V:

N = 8 leads, 12 inches long

T = Series wired motor and 12-foot quick-disconnect cable included

V = Parallel wired motor and 12-foot quick-disconnect cable included



To confirm your selection, review the checklist on page G-6.





P33X Motor in [mm]

CE, cULUS certified

x = N 12 inch, 8 conductor flying leads
 T 12 foot, 5 conductor quick disconnect cable wired in series
 V 12 foot, 5 conductor quick disconnect cable wired in parallel

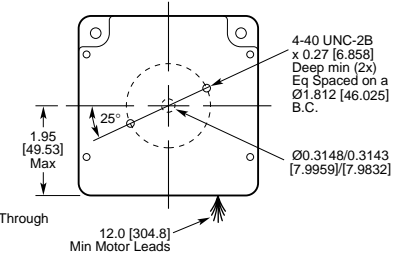
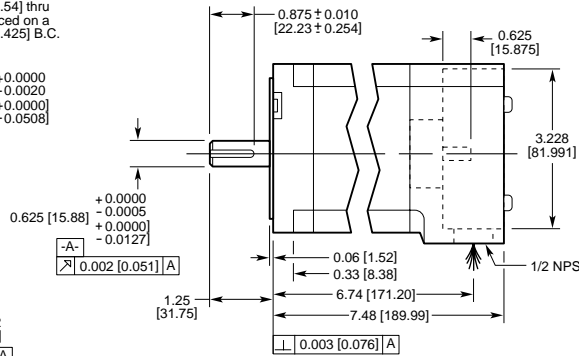
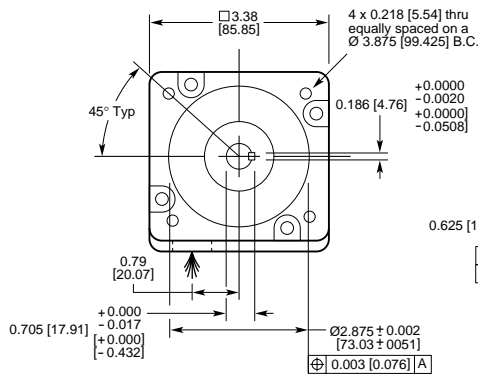

Motor Performance

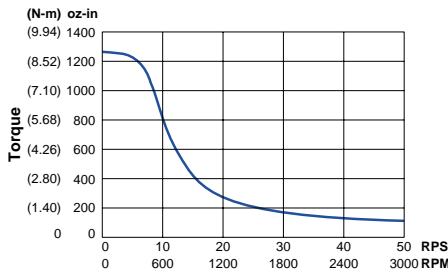

120 Parallel/240 Series (100% duty cycle)

A 30% torque safety margin is recommended when applying step motors.



Please note: In order to get the performance curve shown above, motors should be wired in parallel when the drive is operated from 120 VAC; and motors should be wired in series when the drive is run off 240 VAC.

Motor and Encoder Data

	P33 Series	P33 Parallel
Continuous Stall Torque oz-in [N-m]	1260 [8.9]	
Recommended Current/Phase Amps	2.0	4.0
Inductance mH	100	25
Max. Motor Winding Temp. °F [°C]	212 [100]	
Rotor Inertia oz-in-s ² [kg-m ²]	0.057 [4.0x10 ⁻⁴]	
Axial Shaft Load lbs [N]	305 [1350]	
Radial Shaft Load @ 0.5" [12.7 mm]	110 [489]	
Motor Weight lbs [kg]	11.9 [5.4]	
Step Angle (full step) degrees	1.8	
How to order	G-46	

Performance Planetary Gearmotors

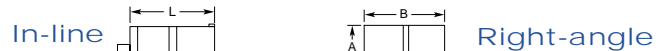

Gear Ratio in [mm]	In-line	Right-angle
3 to 10	L	A x B
16 to 100	11.7 [297.2]	5.20 x 16.64 [132.1 x 422.7]
160 to 700	12.8 [325]	5.20 x 17.77 [132.1 x 451.4]
	14 [356]	Above 100:1, not available

Applying Gearmotors

- See page I-1 for IDC gearmotor information and for how to determine gearmotor performance

Value Planetary Gearmotors

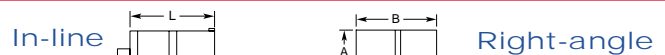

Gear Ratio in [mm]	In-line	Right-angle
3 to 10	L	A x B
16 to 100	12.0 [305]	5.20 x 17.01 [132.1 x 432.1]
	13.2 [335]	5.20 x 18.28 [132.1 x 464.3]



Specifications

Encoder
Options

The -EMK option provides an incremental 1000 line rotary encoder coupled to the rear shaft of our S, P and K Series step motors.

The -EM option provides an incremental 500 line rotary encoder coupled to the rear shaft of our S, P and K Series step motors.

An encoder is typically used with the SmartStep, S6961 and S6962 programmable step motor controls to provide stall detection and position maintenance. Encoders are also commonly used with displays to provide position information, or to provide position feedback to your own controller when using our NextStep® or S6002 drive.

-EM and -EMK are compatible with:
S, P and K Series step motors and gearmotors, sizes 23, 34 and 42

Electrical

Output Format	Incremental, dual square wave quadrature, with index.
-EMK Pulses Per Revolution	1000 line (4000 post-quadrature), one index line
-EM Pulses Per Revolution	500 line (2000 post-quadrature), one index line
Supply Voltage	5VDC \pm 5 %
Current Requirements	140 mA
Frequency	100 kHz pre-quadrature, max.

Mechanical

Outline Dimensions	Adds 1.0 inch to the length of 23 frame motors. No dimension change on 34 and 42 frame motors.
Speed	6000 rpm max
Weight	6 oz
Cable	12-foot cable standard

Environmental

Operating Temperature	-10° to 70°C (S Series, P2X Series), -10° to 100°C (P3X, P4X & K Series)
Storage Temperature	-20° to 70°C (S Series, P2X Series), -30° to 110°C (P3X, P4X & K Series)
Housing	Drip-proof
Vibration	10 to 200 Hz @ 5Gs (S & P2X Series), 5-2000 Hz @ 10 Gs (P3X, P4X & K Series)
Shock	100G for 6 ms (S & P2X Series), 50 G for 11 ms (P3X, P4X & K Series)

Notes:

- S32, S33, P31, P32, P33, P41, P42, and K42 motors: the encoder is housed inside the rear plate of the motor.
- The encoder adds 1.0 inch to the length of the S21, S22, S23, P21 and P22 motors.
- The encoder cable can be extended by the customer to a maximum of 100 feet if a high quality shielded, twisted pair cable is used.